

Fuel Pump Modules
Fuel Pumps
Fuel Pressure Regulators

NINGBO ROCKET AUTOMOBILE PARTS CO., LTD.



Company Profile

- Founded in March 2003;
- Mainly for O.E., 20% for aftermarket;
- Cooperate with over twenty car-makers;
- Supply to famous multinational companies;
- Provide mini fuel pumps for motorcycles;
- Developed new pumps with our own I.P.R.;
- ISO/TS 16949 audited by Germany DQS.



NINGBO ROCKET AUTOMOBILE PARTS CO., LTD.



Organization Structure & H.R.

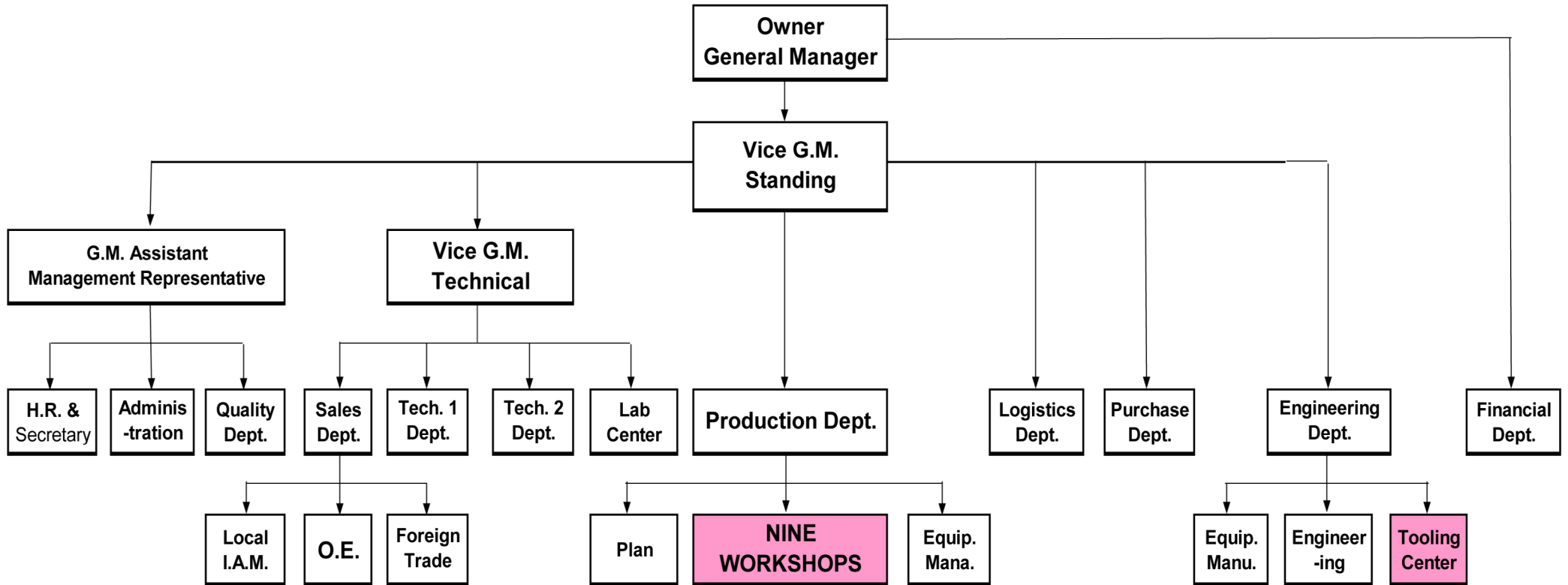

- Staff Quantity: over 500 people
- Professionals: over 80 people

NINGBO ROCKET AUTOMOBILE PARTS CO., LTD.



Main Customers - OEM



比亚迪汽车
BYD AUTO



哈飞汽车集团
HAFEI AUTOMOBILE GROUP



NINGBO ROCKET AUTOMOBILE PARTS CO., LTD.



Main Customers – OES / IAM



BOSCH

VDO



**FEDERAL
MOGUL**

AIRTEX.

Holley

NINGBO ROCKET AUTOMOBILE PARTS CO., LTD.



OEM Applications - FAW



Front-Engine Rear-Drive

Drive Shaft (F→R)

Saddle Fuel Tank

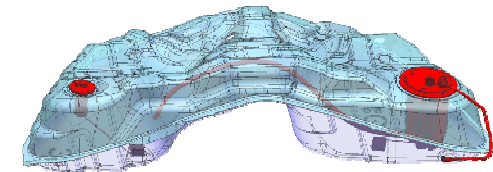

FAW 红旗 HONGQI C131 – H7

Launch: Apr. 20, 2012

Class-C Vehicles: L-5095, W-1875, H-1485, Wheelbase-2970 (mm)

Displacement: 2.0T, 2.5, 3.0 Price: CNY250,000.00 – 350,000.00

NINGBO ROCKET AUTOMOBILE PARTS CO., LTD.



OEM Applications - NISSAN



MARCH & SUNNY

Made in Zhengzhou China

NISSAN Global Supplier Code: **5BR3**

Project Platform: 719

Dongfeng NISSAN Supplier Code: **C270**

NINGBO ROCKET AUTOMOBILE PARTS CO., LTD.



OEM Applications - CHEVROLET



SPARK G1 & G2

Made in Liuzhou China

NINGBO ROCKET AUTOMOBILE PARTS CO., LTD.



Product Range

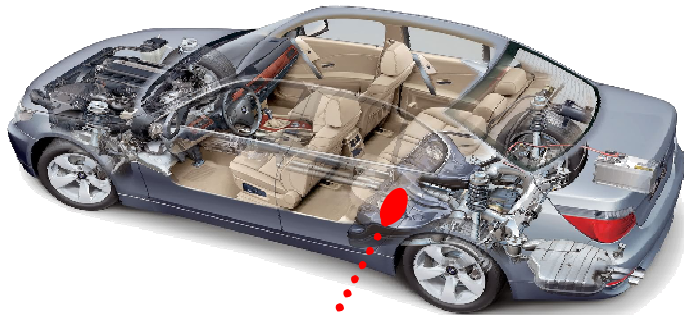

Fuel Pump Modules for Auto and Moto

Development, Manufacture and Service, include:

Fuel Pumps, Fuel Pressure Regulators, Fuel Level Sensors,

Roll-Over Protector and Tank Pressure Adjustor, General and

Fine Filters, Jet Devices and others.

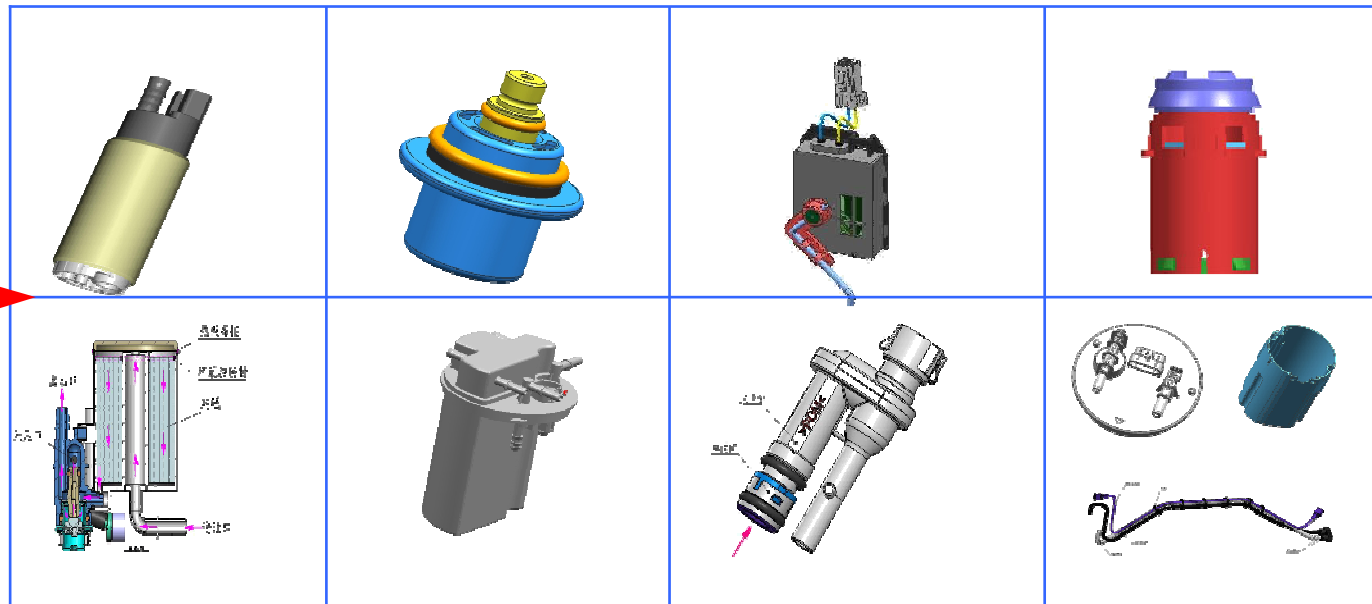
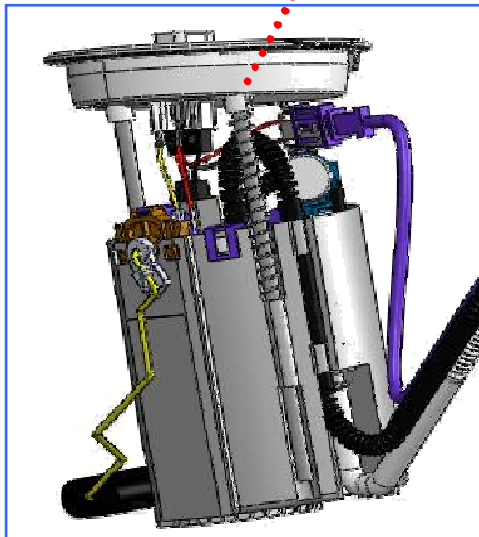

NINGBO ROCKET AUTOMOBILE PARTS CO., LTD.

Production Capacity



- Fuel Pump Modules
4 million sets per year



- Fuel Pumps
6 million pieces per year



- Fuel Pressure Regulators
6 million pieces per year



Core Advantages

Research and Development →

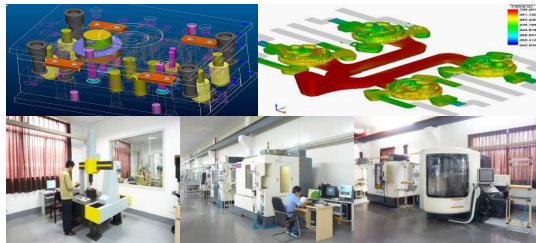

← Tooling Center of Moulds and Dies

In-House Production of Components →



← In-Process Automation Facilities

China Best Lab of Fuel Pumps →



NINGBO ROCKET AUTOMOBILE PARTS CO., LTD.



Fuel Pumps for Automobile OEM

1. Fuel Pumps QB0118

-- With copper commutators.

2. Fuel Pumps QB0118G

-- The same sizes with QB0118, with graphite commutators.

3. Fuel Pumps QB0180

-- With our own intellectual property right, with graphite commutators.

4. Fuel Pumps QB0302 and QB0302A

-- With graphite commutators, with overmold RFI and wires.

5. Fuel Pumps QB0128



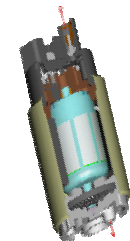

-- Jet pumps specially for saddle fuel tanks, with dual-channel turbines.

★ Fuel Pump Modules: Over 60 Types Directly for Car-Makers



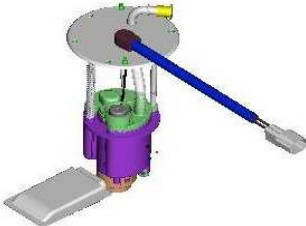

Fuel Pumps for Motorcycle OEM

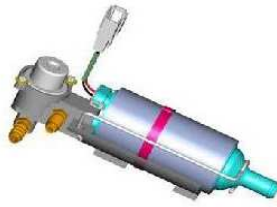
Fuel Pumps and Modules for Motorcycle OE Projects					
Type QB0175 In-Tank Fuel Pump	Type FPR002A Fuel Pressure Regulator	Type PW3001 In-Tank Fuel Pump Module	(12 V, 0.3 mPa)	@ (8V, 0.25 mPa)	Life Time
			≥ 20 L/h, ≤ 2 A	≥ 5 L/h	> 5000 hours
Type QB0155A In-Line Fuel Pump	Type FPR002A Fuel Pressure Regulator with Scocket	Type PW3002 In-Line Fuel Pump Module	@ (12 V, 0.27 mPa)	@ (8V, 0.27 mPa)	Life Time
			≥ 25 L/h, ≤ 2 A	≥ 5 L/h	> 3000 hours



Workshop Layout

Total Construction Floor: 62,000 sqm

No.	Workshop Names	SQM	Facilities
0	Tooling Center	1188	42 sets
1	Injection Molding (2)	2160+500	No. 1 – 37 sets; No. 2 - 9 sets
2	Metal-Cutting	2640	72 sets
3	Metal-Stamping	2000	14 sets
4	Galvanizing and Anodizing	2000	1+1 lines
5	Fuel Pressure Regulators	300	3 lines
6	Strainers	200	4+3 sets
7	Armatures	2640	86 sets, 6 lines
8	Fuel Pumps (2)	2640+1440	No. 1- Turbine Pumps, 4 lines; No. 2 - Other pumps, 4 lines
9	Fuel Pump Modules (2)	2640+1440	No. 1 - 6 lines; No. 2 – 4 lines

NINGBO ROCKET AUTOMOBILE PARTS CO., LTD.



Quality Management System

ISO/TS 16949 : 2009

- Audit Body: Germany DQS
- Cert. Reg. No.: 306858 TS09
- IATF No.: 0111159
- Valid Period:
2010/10/13 – 2013/10/12
- Product Scope:
Fuel Pumps
Fuel Pump Modules
Fuel Pressure Regulators
- Three times of Audit
2004, 2007, 2010

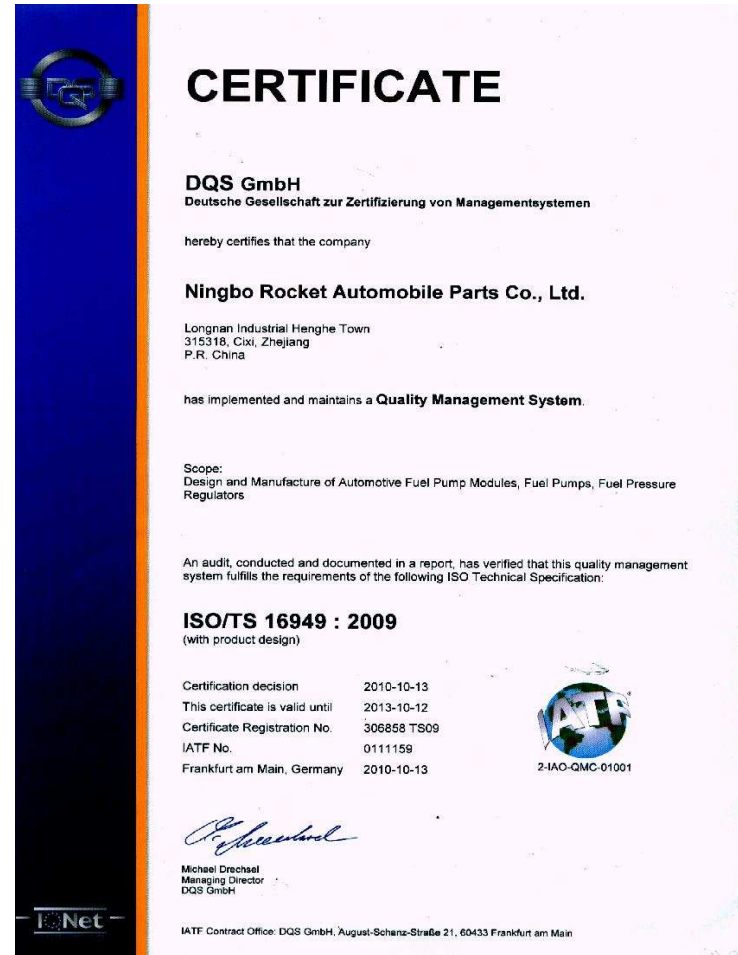

NINGBO ROCKET AUTOMOBILE PARTS CO., LTD.



Three Factories

- Move into New Factory in June 2011
- Easily to be expanded in Space

No.	Places	Land (sqm)	Floor (sqm)
1	New Factory	27,000	45,000
2	Old Factory	10,000	15,000
3	Galvanizing and Anodizing	3,000	2,000
TOTAL		40,000	62,000





Regional Superiority

➤ To Shanghai

- 2.5 hours by car
- Two int'l airports (PVG & SHA)
- Shanghai seaport
- Grand Bridge: 36 km

➤ To Hangzhou

- 2.0 hours
- Xiaoshan int'l airport (HGH)

➤ To Ningbo

- 1.5 hours by car
- Lishe int'l airport (NGB)
- Ningbo-Zhoushan seaport
- Biggest seaport in China

➤ To Yuyao Railway Station

- 0.5 hour by car
- Express trains



NINGBO ROCKET AUTOMOBILE PARTS CO., LTD.

Thank you!



South, Andong Industrial Zone, Cixi, Zhejiang, 315327 China

Contact: Mr. Simon Hu

M.Phone: +86-(0)183.586. 49705

E-Mail: simon@luokate.com

E-Mail: simon201205@hotmail.com

Skype: SimonHu

MSN: simon201205@hotmail.com

Previous Name: NINGBO RECTOR AUTOMOBILE PARTS CO., LTD.

NINGBO ROCKET AUTOMOBILE PARTS CO., LTD.